

SIRUBA®

銀箭牌工業用縫紉機
INDUSTRIAL SEWING MACHINE

L818F-DM1

WITH TRIMMER







零件圖 PARTS LIST

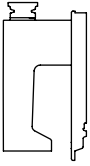

CE

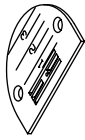
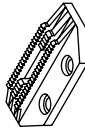
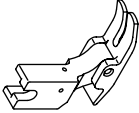

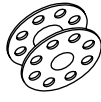
高林股份有限公司
KAULIN MFG. CO., LTD.

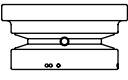
										
MODEL	SUB-CLASS	OPERATING PANEL	NEEDLE PLATE	FEED DOG	PRESSER FOOT	HOOK ASM	BOBBIN CASE ASM	BOBBIN	NEEDLE	HAND WHEEL
機 型	規 格	操作盒	針 板	送 具	押 具	梭 頭	梭 殼	梭 子	針 號	皮 帶 輪
L818F-DM1-00 ? L818F-DM1-03		LA55F-A	E704	D701	P701	G121	G202	G303	DB*1#11	LH01-A
L818F-DM1-00A ? L818F-DM1-03A	半無油式	LA55F-A	E704D	D701	P701	G121	G202	G303	DB*1#11	LH01Q-E
L818F-DM1-10 ? L818F-DM1-13	中厚布料	LA53G-A	E704	D701	P701	G121	G202	G303	DB*1#11	LH01-A
L818F-DM1-K10 ? L818F-DM1-K13		L600A	E704	D701	P701	G121	G202	G303	DB*1#11	LH01P-A

PARTS LIST FOR LG GROUP

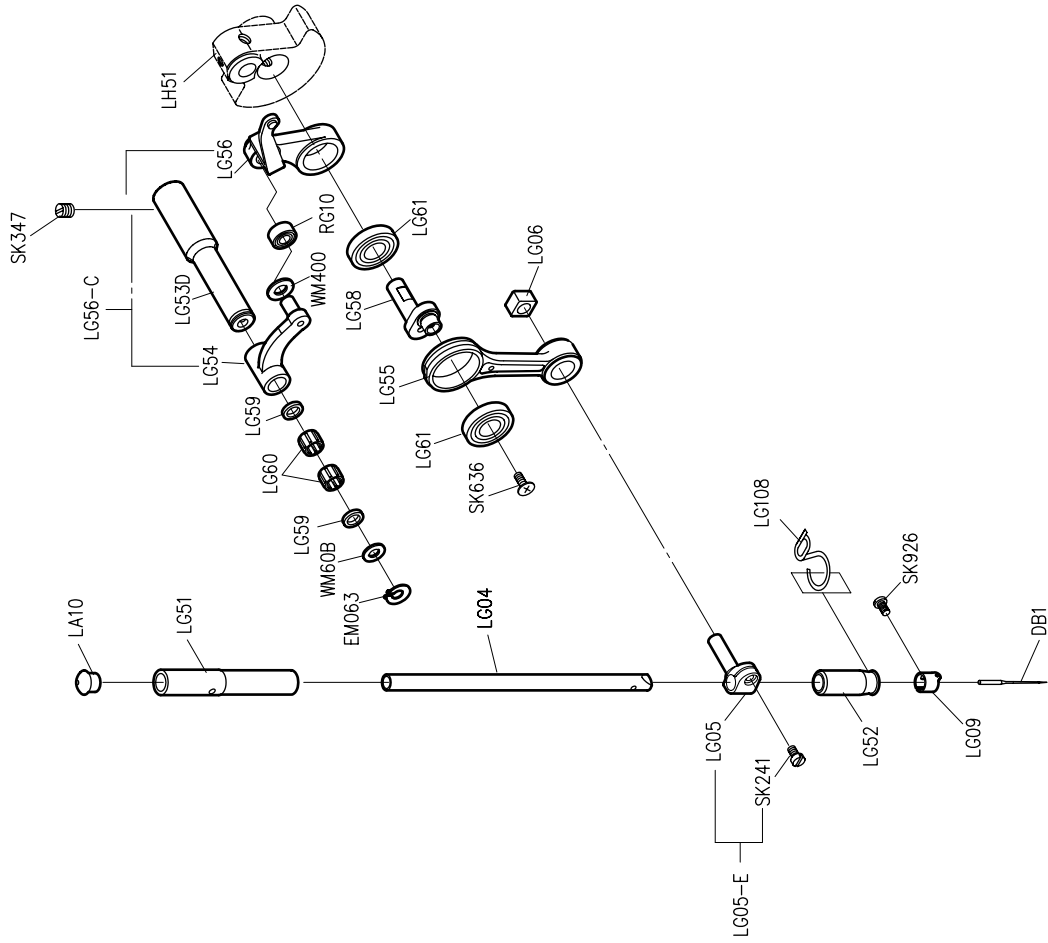

PARTS LIST FOR LE GROUP

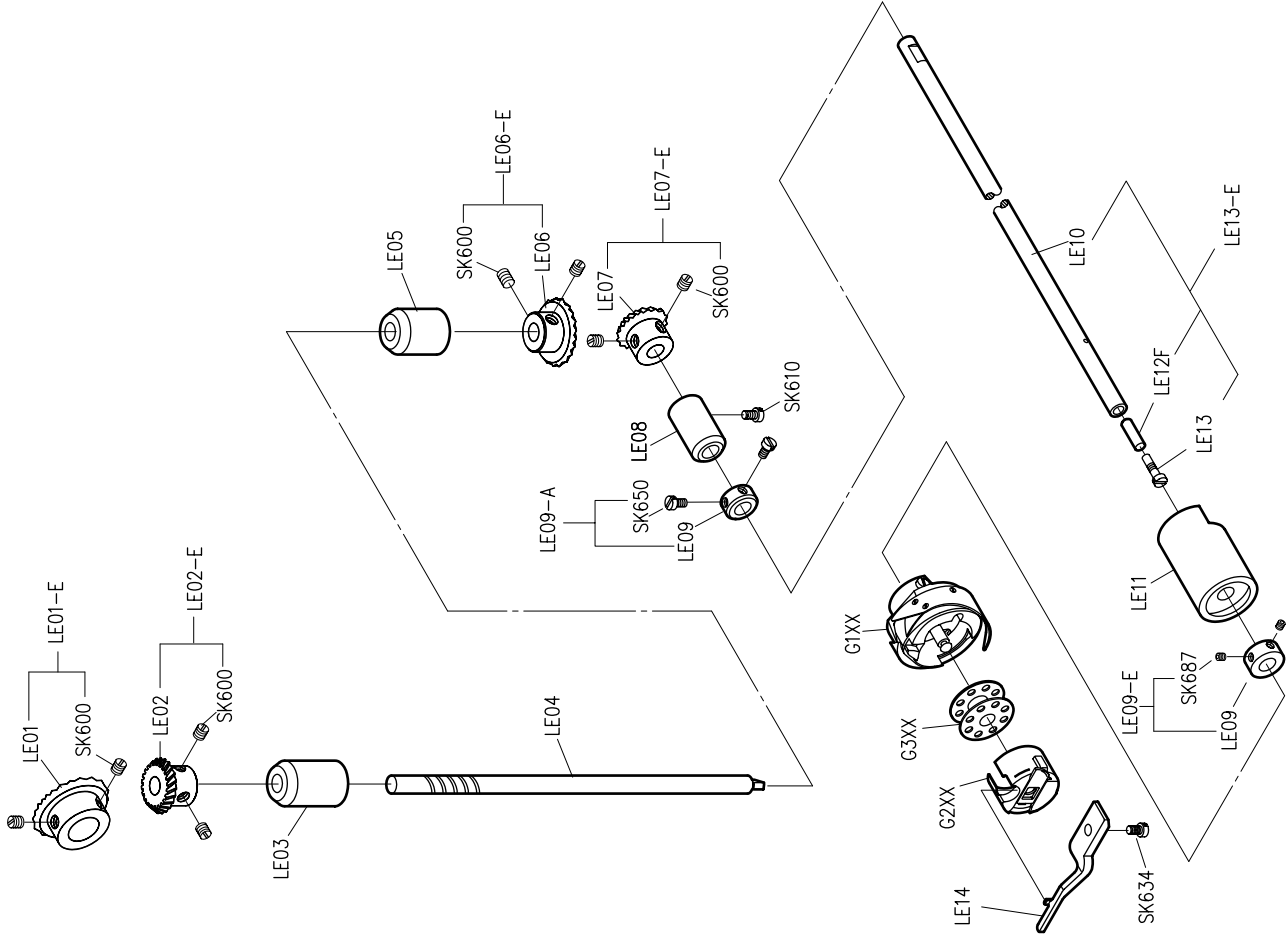

PARTS LIST FOR LM GROUP

LM010-A

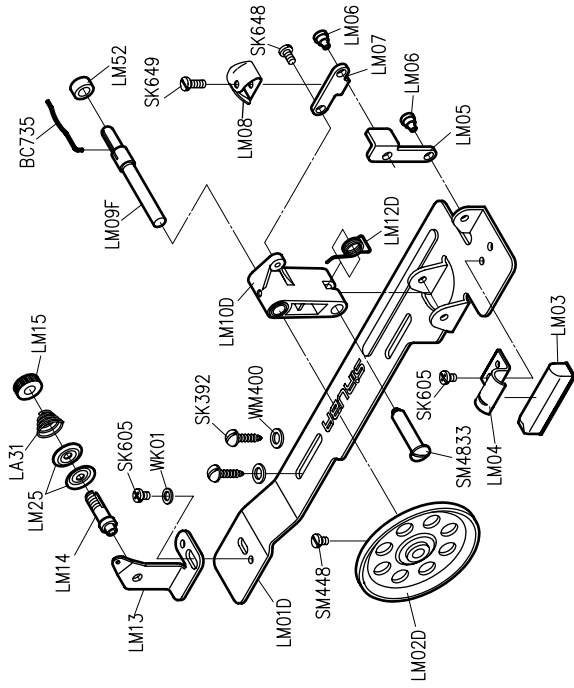

LM24-E

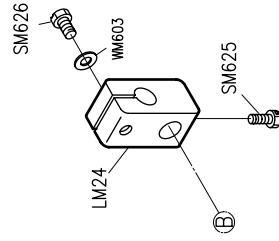

LM20-A

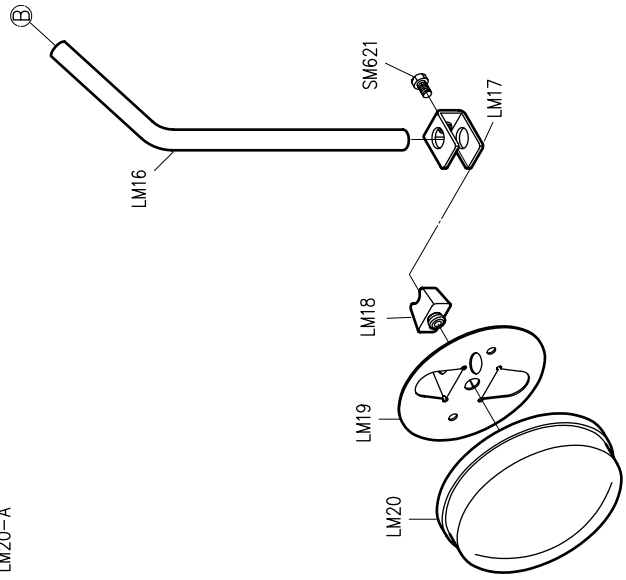

PARTS LIST FOR LL GROUP

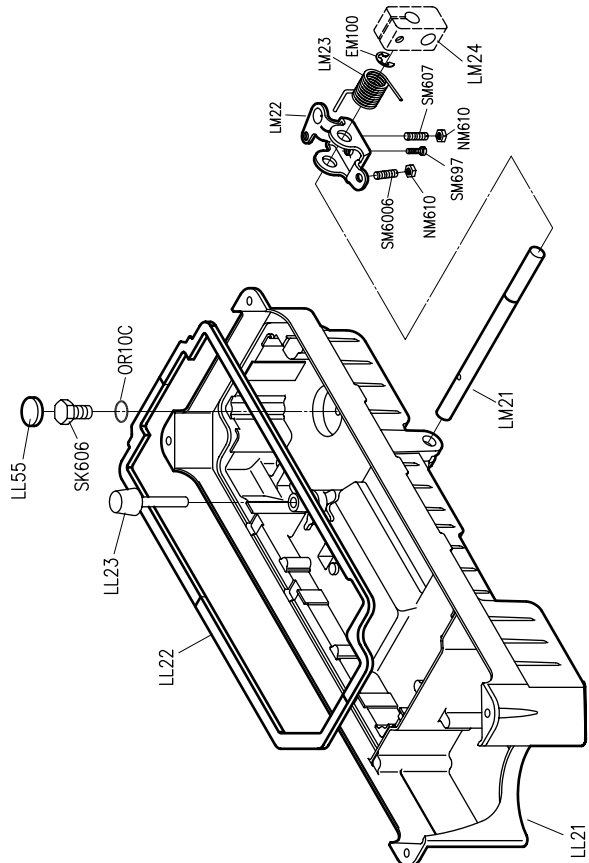
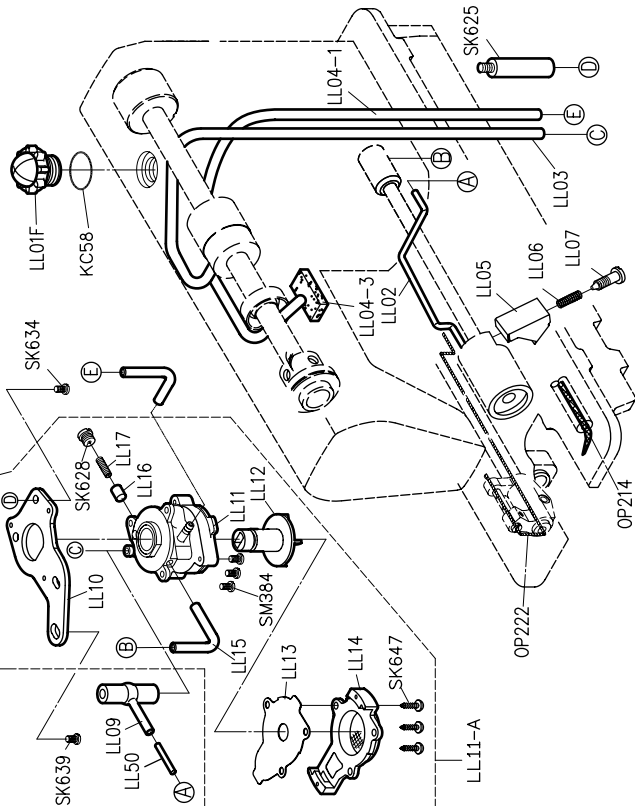

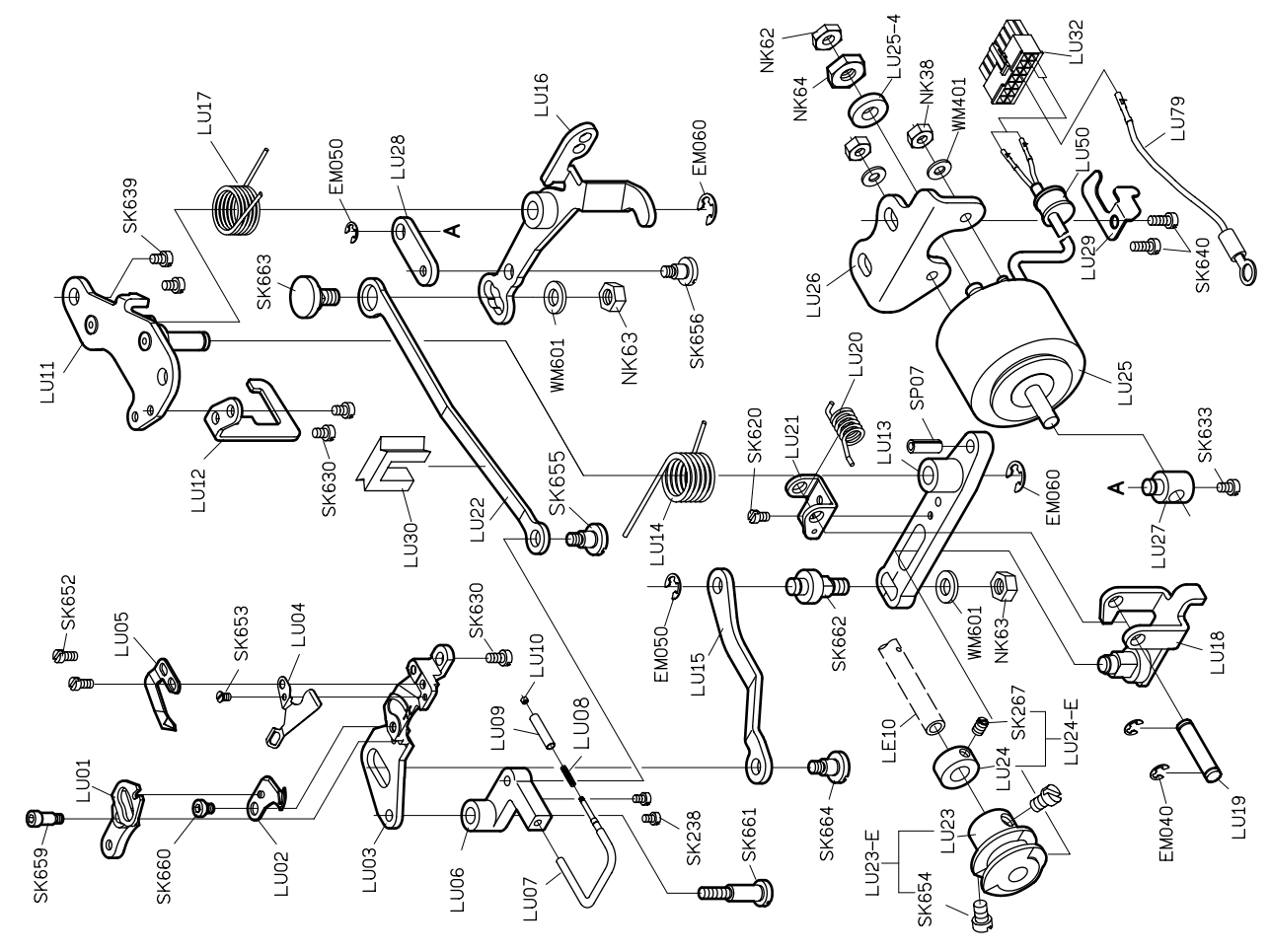
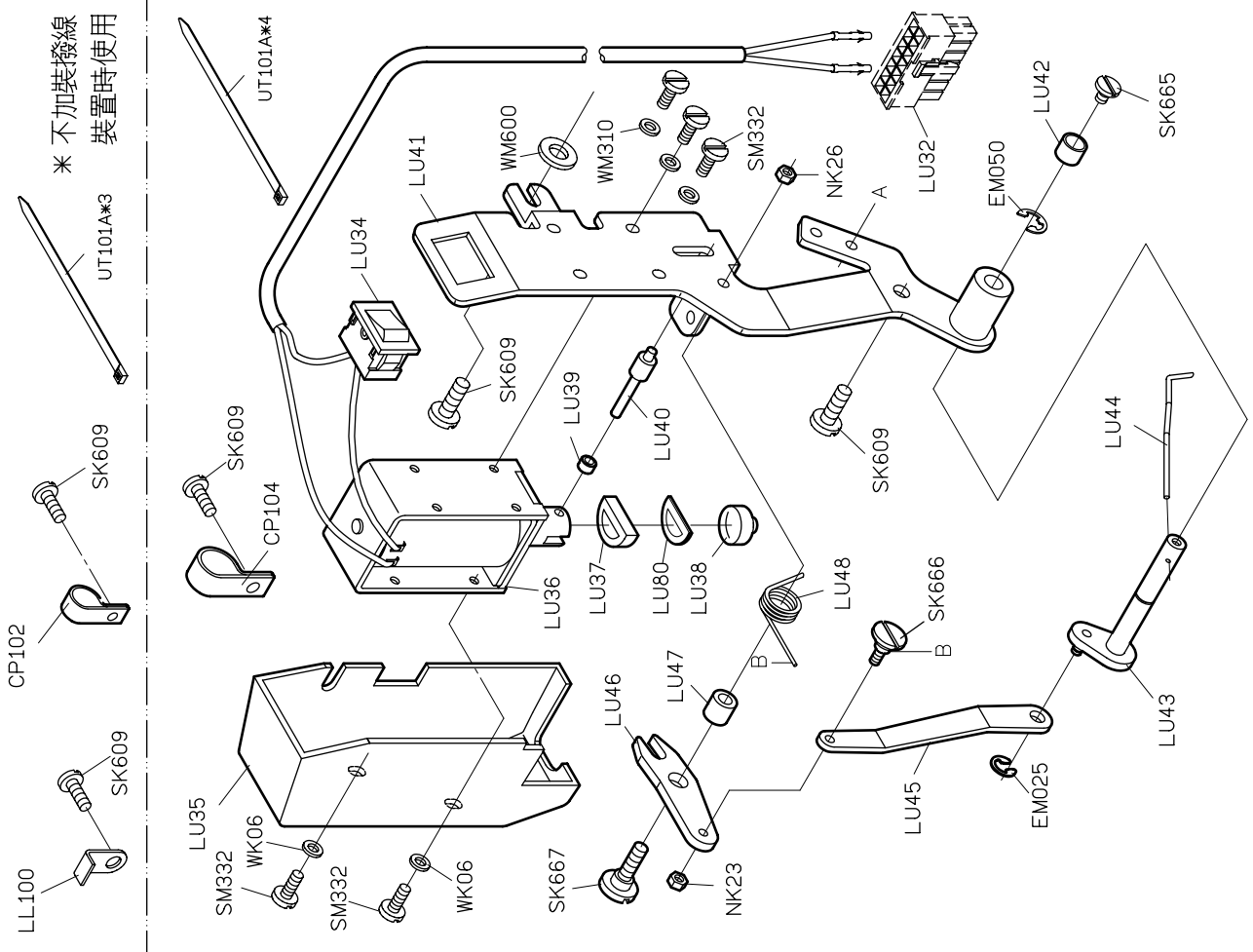

CP102
SK609
LL100
UT101A*3
UT101A*4
* 不加裝發線
裝置時使用

PARTS LIST FOR LU GROUP

PARTS LIST FOR LU GROUP

PARTS LIST FOR LU GROUP

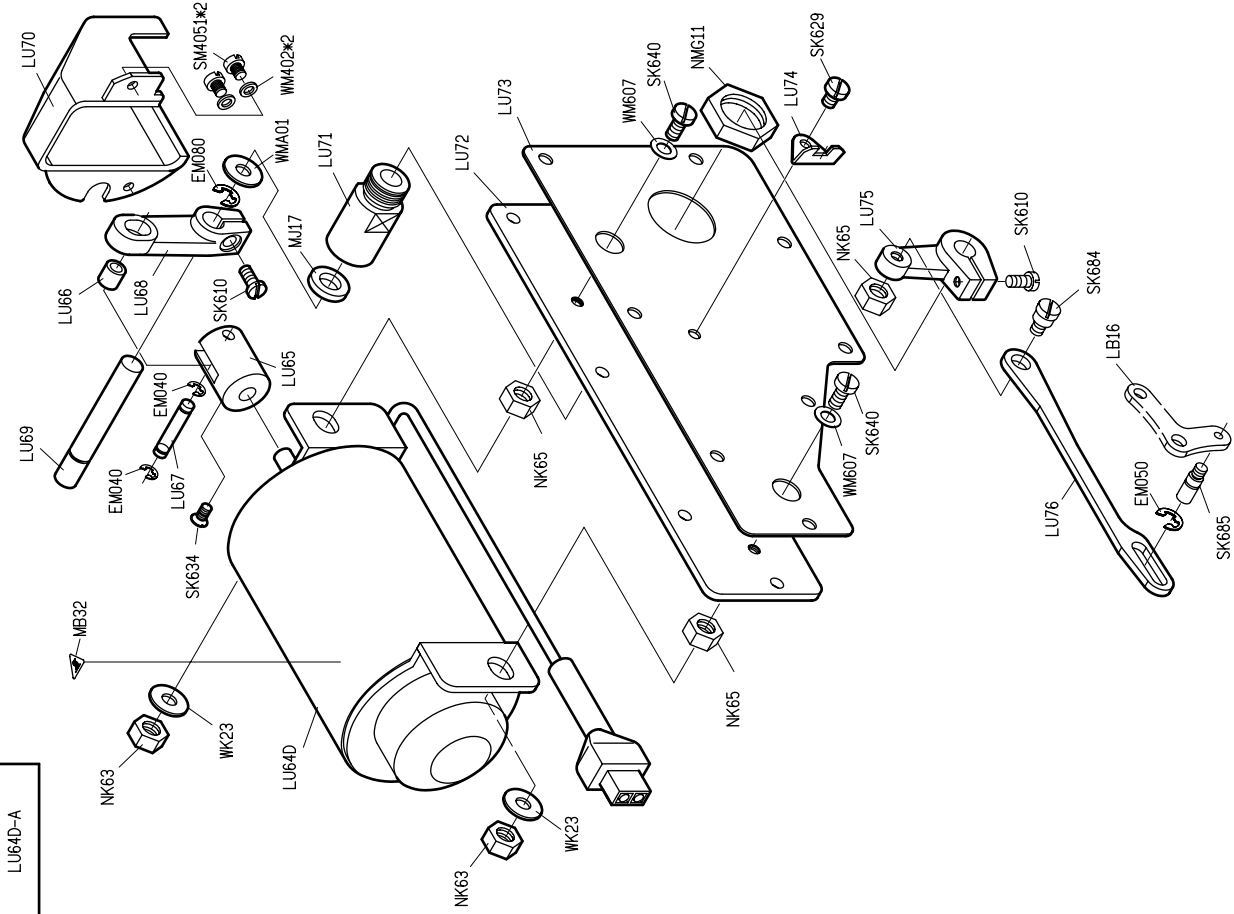

PARTS LIST FOR LU GROUP

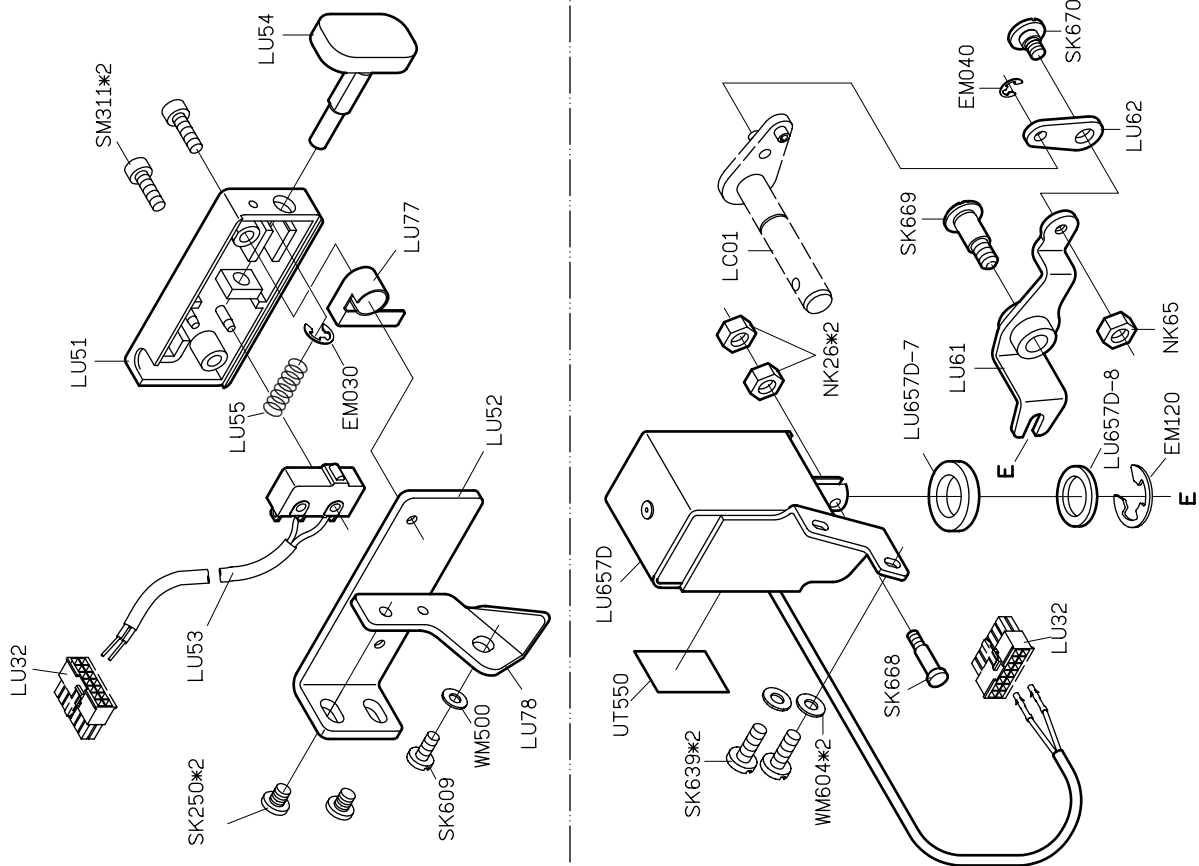

T666 (定位馬達)
T777 (伺服馬達)

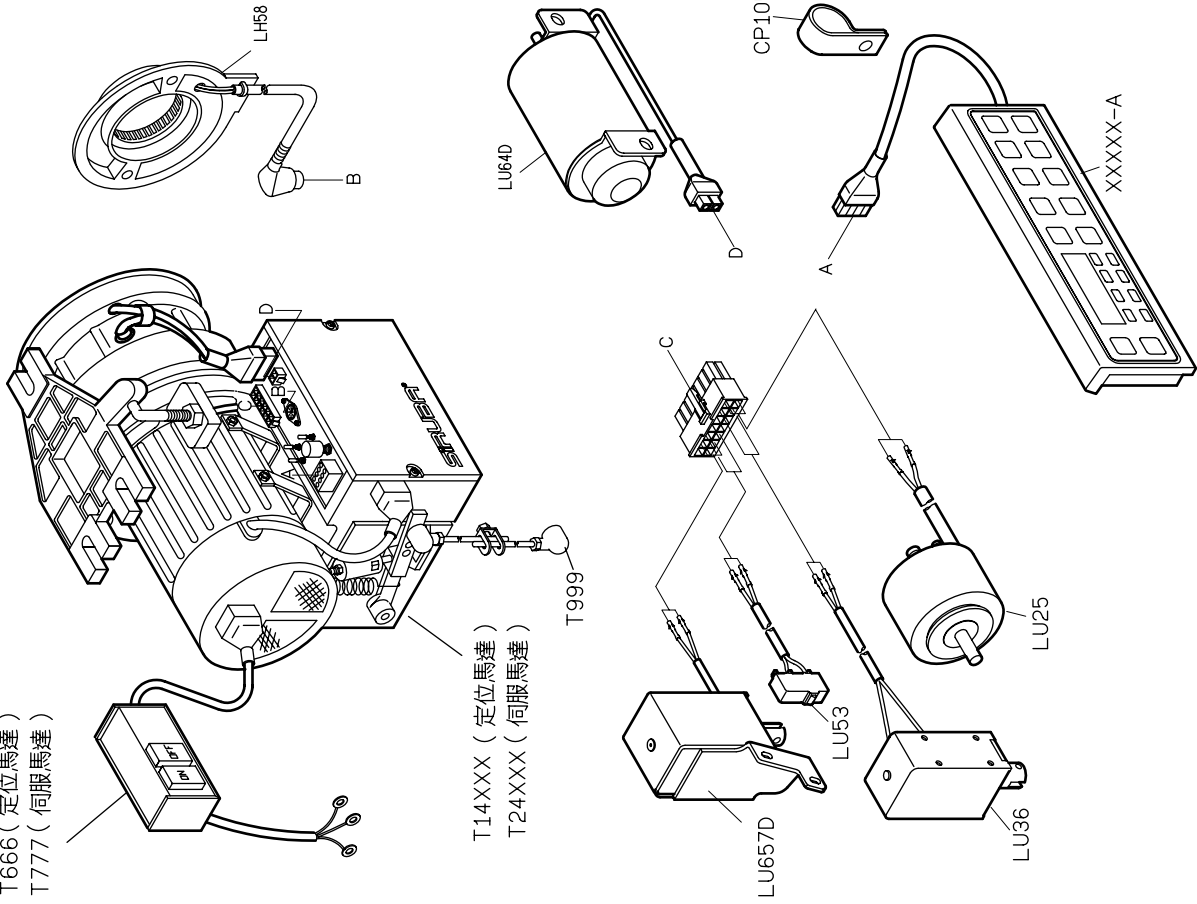

T14XXX (定位馬達)
T24XXX (伺服馬達)

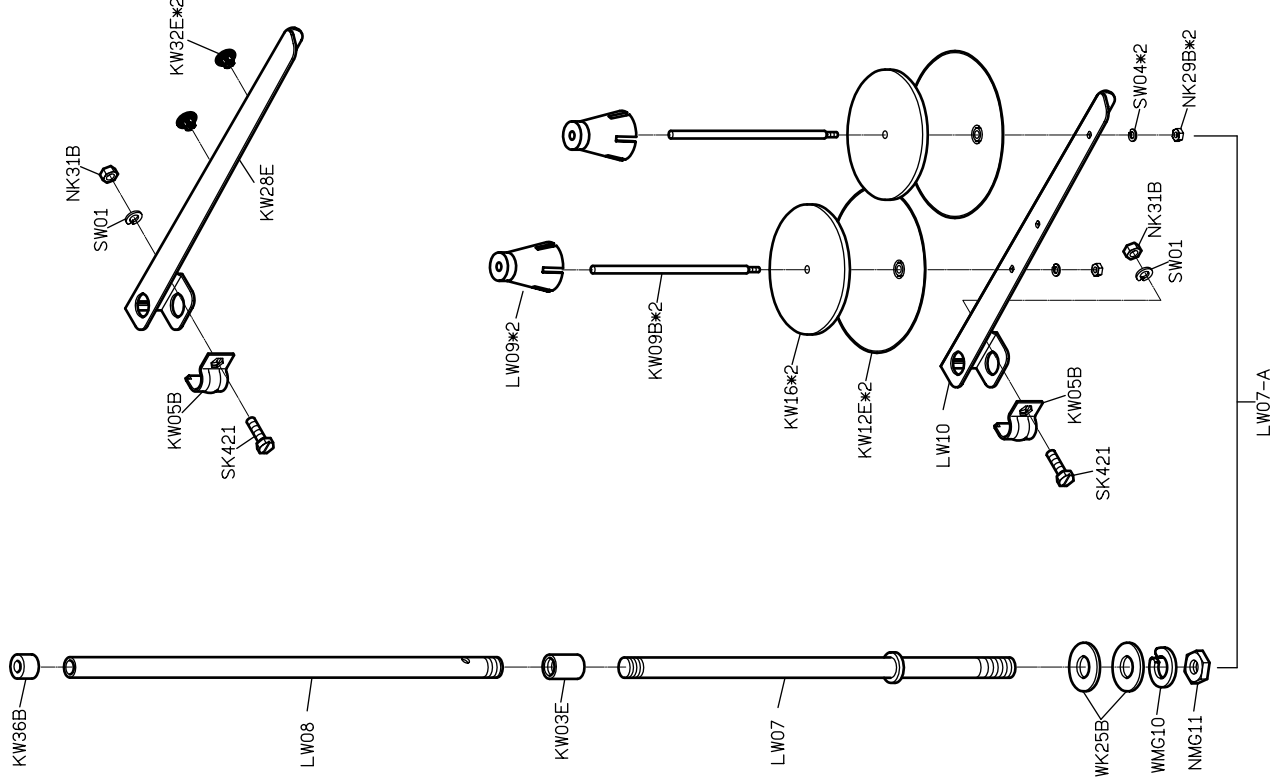

PARTS LIST FOR LY GROUP



LY01

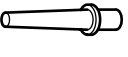

LY02

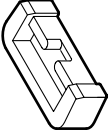

YM04*2

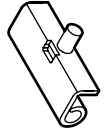

LY05*2



YM102*2

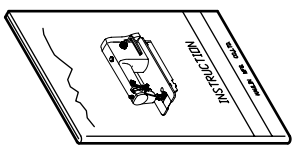

LY08F

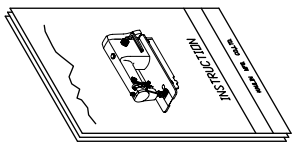

LY18

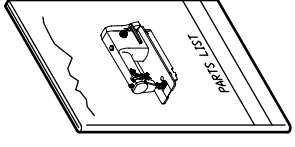

LY27

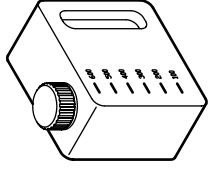

LY21-A



YM103*2



G3XX*2



LY20*8



MY02

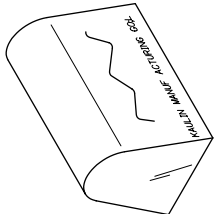

MY01



3 mm

MY11



KZ03*1

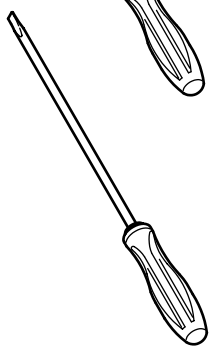

KY16

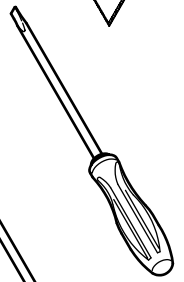

KY17

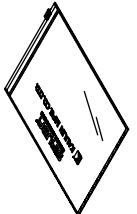

KY26F



MY13

PARTS LIST FOR LZ GROUP

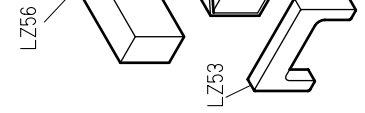

LZ56



LZ52

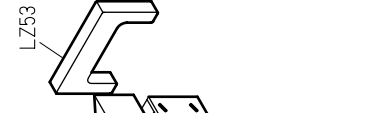

LZ53

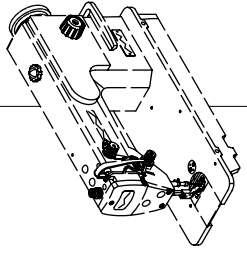

LZ70



LZ71



LZ74



LZ74



LZ69

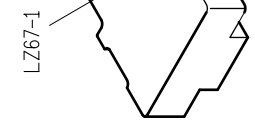

LZ67-1

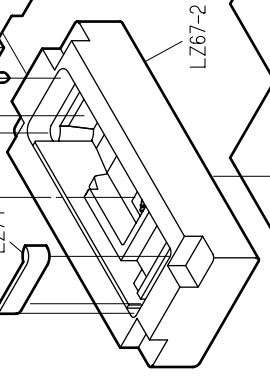

LZ67-2

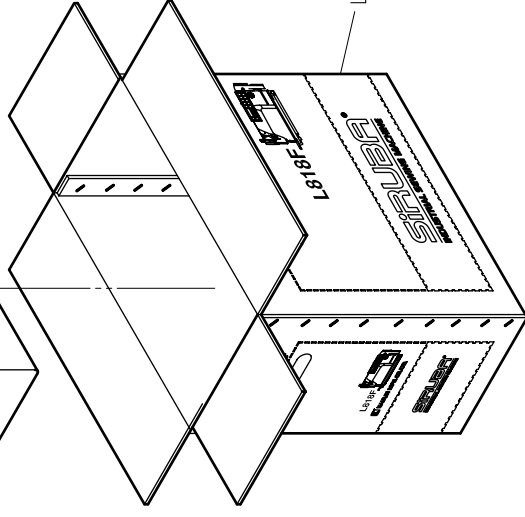

LZ04F



L818F-DM1

WITH TRIMMER

高林股份有限公司 KAULIN MFG. CO., LTD.